

●ロボットの組み立て方 (在来線車両×29、新幹線車両×3、ジョイントA×10、ジョイントB×10使用)

1 腕の組み立て

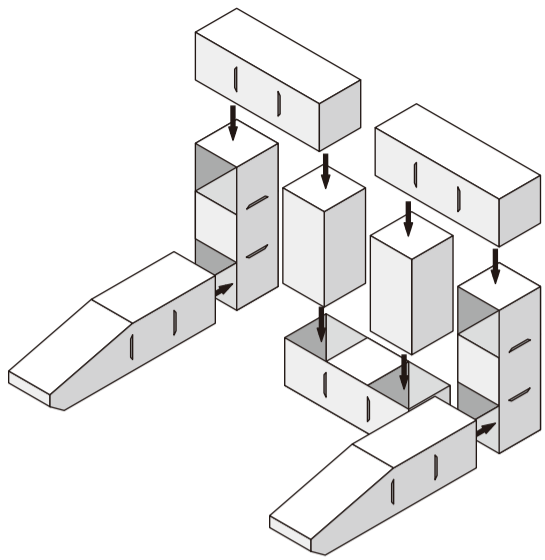

2 足の組み立て(左右二つ分作ります) 3

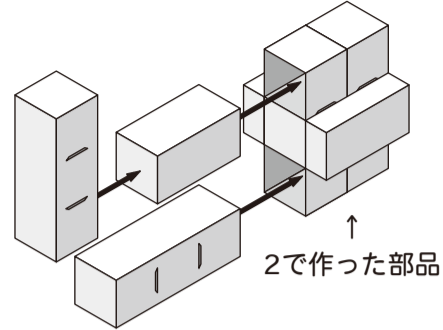
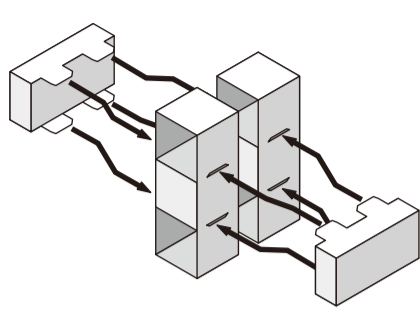

4

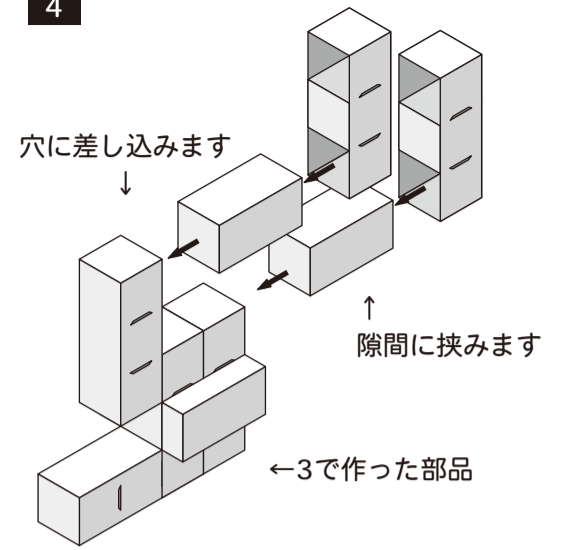

5 左右の足の接続

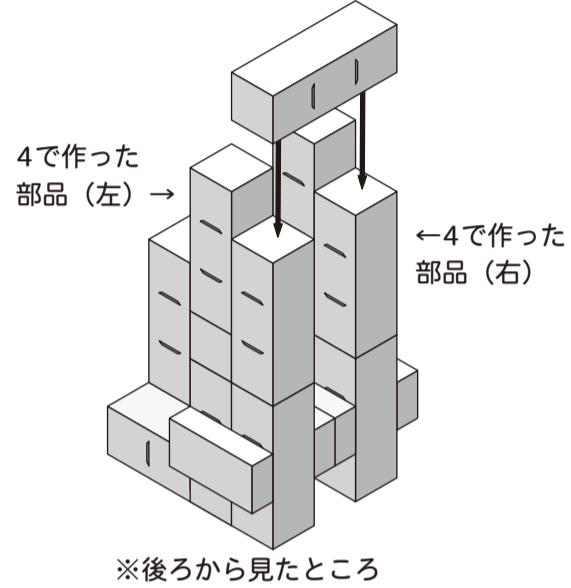

6

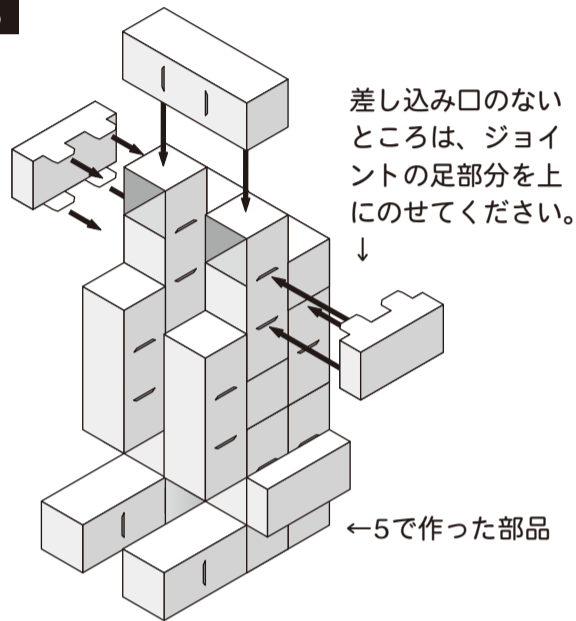

7 腕と足の接続

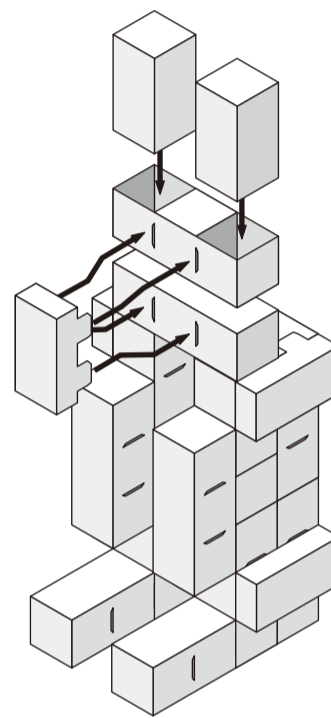

8 (腕を背中側にのせます)

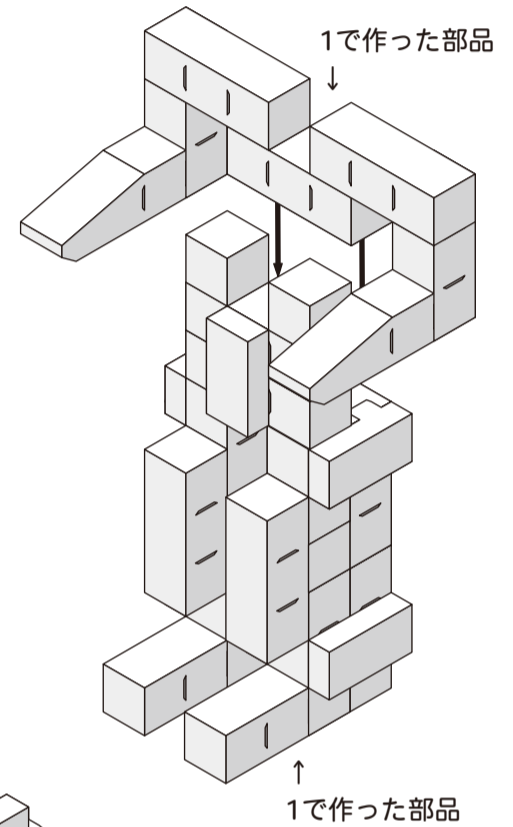

9

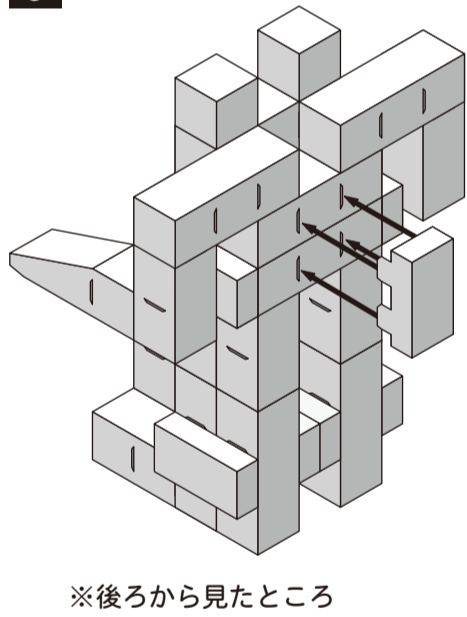

11 頭の組み立て

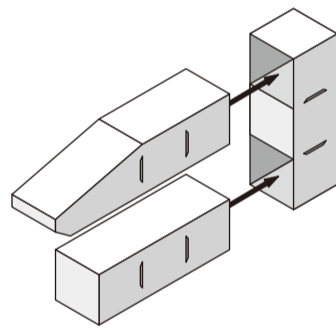

12

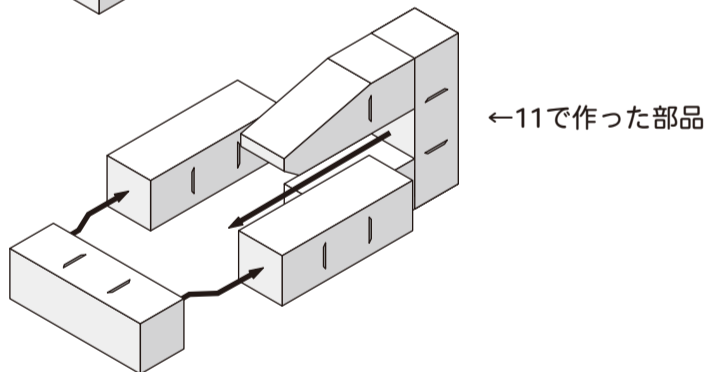

14

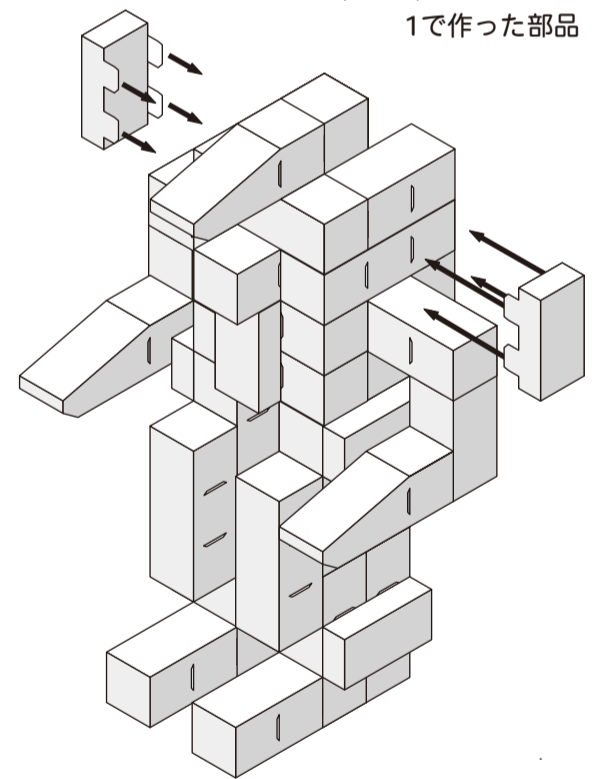

10

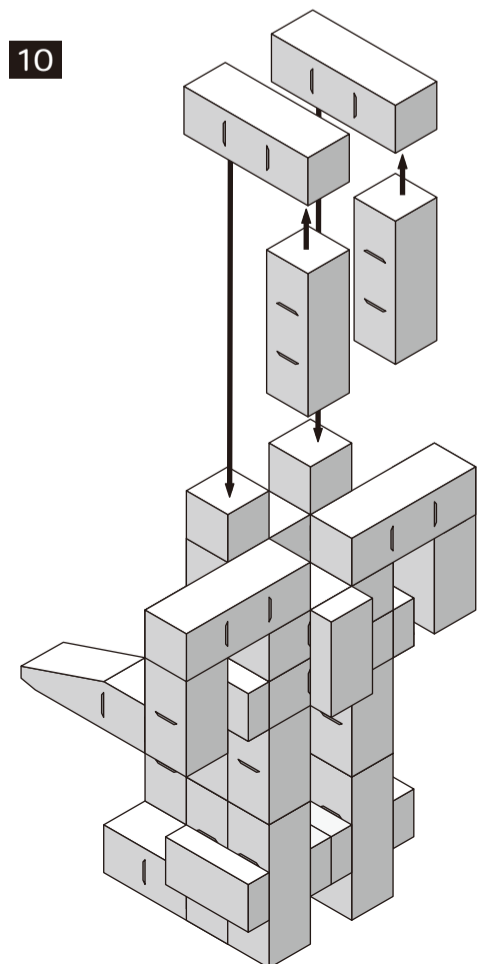

13 頭と胴体の接続

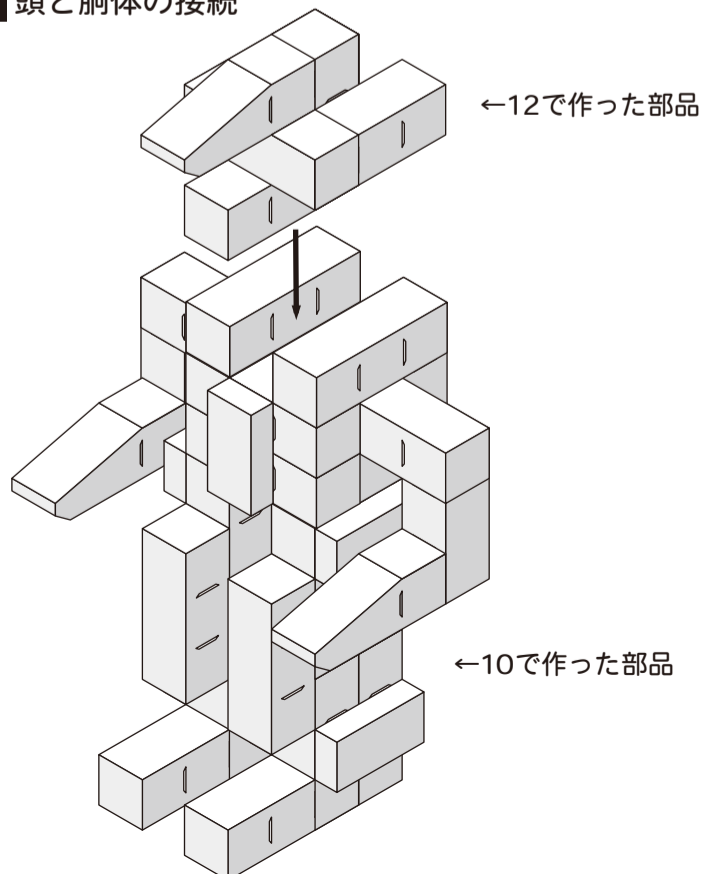

15 完成

